

INDUSTRIAL RANGE

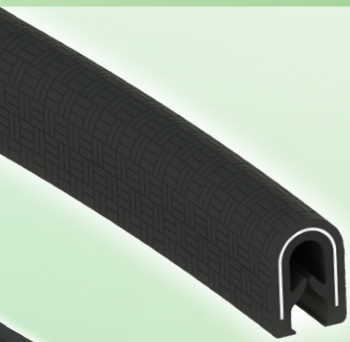

Pinchweld Trims



Mats & Sheet Rubber

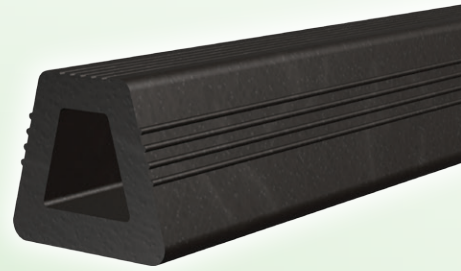

Docking Rubbers

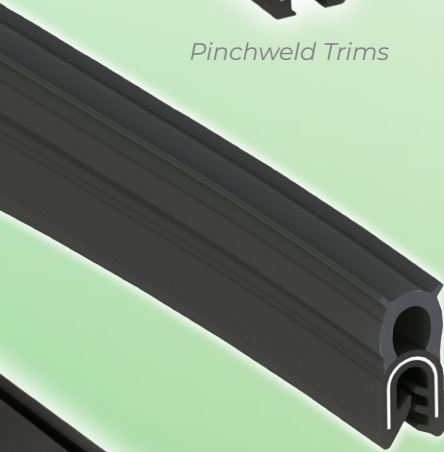

Pinchweld Co-extrusions

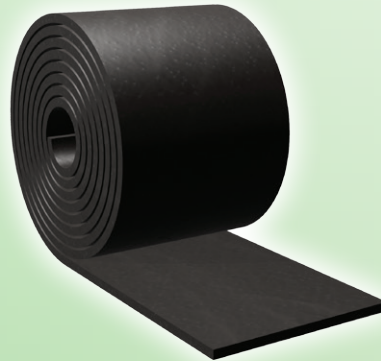

Insertion Strip

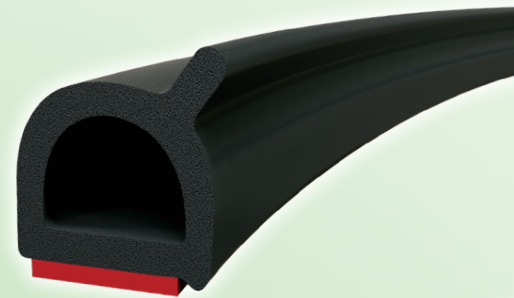

Sponge Seals

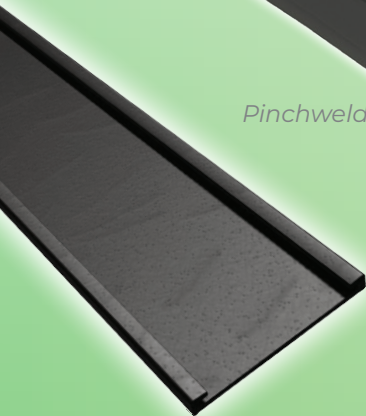

Tank Straps

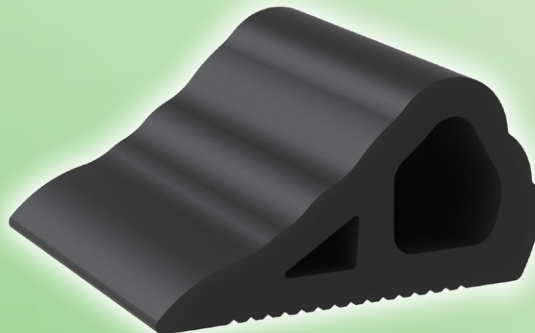

Wheel Chocks



Glazing Rubbers

2024

Self-Adhesive Sponge Seals

OZ-50110-RL50



NEW

✶ EPDM Sponge ✶ 50m Roll

OZ-50109-RL33

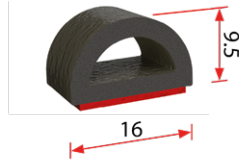

NEW

✶ EPDM Sponge ✶ 33m Roll

OZ-135AT-RL33

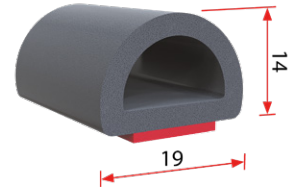

✶ EPDM Sponge ✶ 33m Roll

OZ-019-RL66

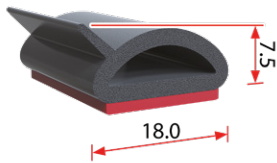

✶ EPDM Sponge ✶ 66m Roll

OZ-50449-RL33

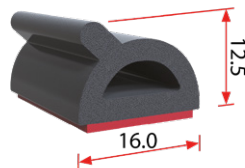

✶ EPDM Sponge ✶ 33m Roll

OZ-5036-RL228

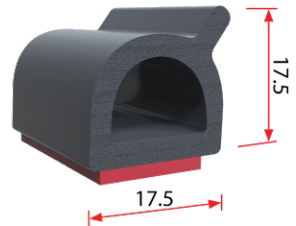

✶ EPDM Sponge ✶ 228.6m Roll

OZ-5036-2-RL33

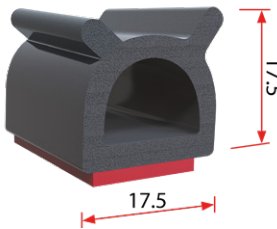

✶ EPDM Sponge ✶ 33m Roll

TPR

OZ-TP95-RL50

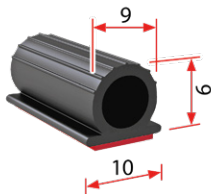

✶ TPR ✶ 50m Roll

Universal Tailgate Seal

OZ-TGSEAL-RL33

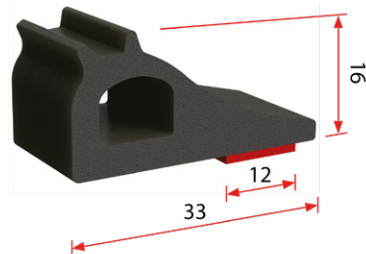

✶ EPDM Sponge ✶ 33m Roll

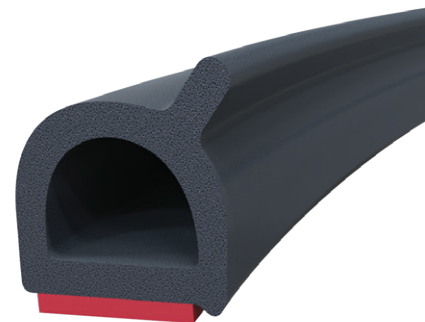

Pinchweld PVC Trims - 50m Rolls

<p>090Z059-RL50</p> <p>BLACK</p> <p>Grip Range: 0.5 - 1.0mm</p>	<p>090Z063-RL50</p> <p>BLACK</p> <p>Grip Range: 1.0 - 2.0mm</p>	<p>07ES18-RL50</p> <p>BLACK</p> <p>Grip Range: 0.5 - 1.2mm</p>	<p>090Z035-RL50</p> <p>BLACK</p> <p>Grip Range: 0.5 - 2.0mm</p>
<p>090Z037-RL50</p> <p>BLACK</p> <p>Grip Range: 1.5 - 4.5mm</p>	<p>090Z056-RL50</p> <p>BLACK</p> <p>Grip Range: 1.0 - 3.5mm</p>	<p>090Z719-RL50</p> <p>BLACK</p> <p>Grip Range: 0.5 - 1.2mm</p>	<p>090Z173-RL50</p> <p>BLACK NEW</p> <p>Grip Range: 0.5 - 1.2mm</p>
<p>186N12-RL50 BLACK</p> <p>186R12-RL50 RED</p> <p>186G12-RL50 GREY</p> <p>186B12-RL50 BROWN</p> <p>Grip Range: 0.8 - 3.5mm</p>	<p>090Z083B-RL50</p> <p>BLACK</p> <p>Grip Range: 4.0 - 5.5mm</p>	<p>090Z083G-RL50</p> <p>GREY</p> <p>Grip Range: 4.0 - 5.5mm</p>	
<p>090Z310-RL50 BLACK</p> <p>090Z311-RL50 SADDLE</p> <p>090Z312-RL50 GAZELLE</p> <p>090Z313-RL50 BUCKSKIN</p> <p>090Z314-RL50 CHAMOIS</p> <p>NEW</p> <p>Grip Range: 2.0 - 5.0mm</p> <p><i>Suits early model Holdens</i></p>	<p>090Z295B-RL50</p> <p>BLACK</p> <p>Grip Range: 2.0 - 5.0mm</p>	<p>090Z295W-RL50</p> <p>WHITE</p> <p>Grip Range: 2.0 - 5.0mm</p>	

Pinchweld EPDM Trim

090Z222-RL50

BLACK
EPDM

Grip Range: 1.0 - 4.0mm

Marine Pinchweld PVC Trim

09AP623W

Grip Range: 1.5 - 4.3mm

61m Roll Marine Grade with Aluminium Clip

by the metre



Pinchweld Co Extrusions - 50m Rolls

090Z2360-RL50

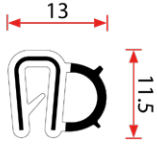

Grip Range: 1.0 - 2.0mm

090Z2359-RL50

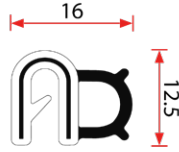

Grip Range: 1.0 - 2.5mm

090Z053-RL50

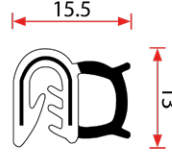

Grip Range: 0.5 - 4.0mm
Wire Cage

090Z058-RL50

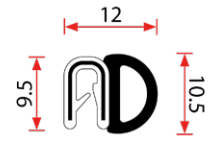

Grip Range: 1.0 - 2.0mm
PVC-EPDM Sponge

NEW

090Z040-RL50

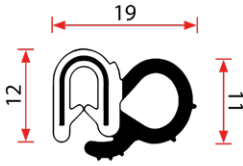

Grip Range: 0.8 - 2.5mm

090Z555-RL50

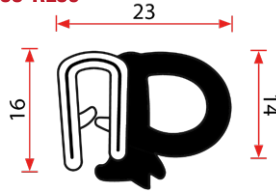

Grip Range: 0.8 - 2.5mm
PVC-EPDM Sponge

090Z054-RL50



Grip Range: 0.8 - 3.0mm
PVC-EPDM Sponge

090Z004-RL50

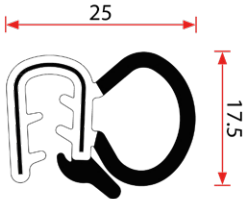

Grip Range: 1.0 - 4.0mm

09LR08-RL50

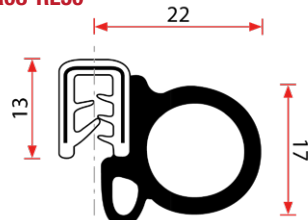

Grip Range: 0.8 - 3.0mm

090Z017-RL50

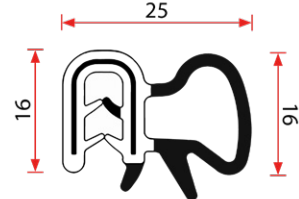

Grip Range: 0.8 - 4.0mm

09BR07-RL50

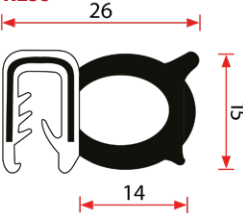

Grip Range: 1.5 - 5.6mm

090Z013-RL50

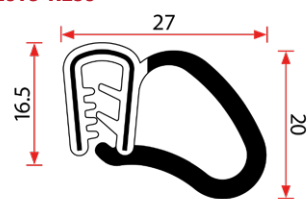

Grip Range: 1.0 - 4.0mm

090Z014-RL50

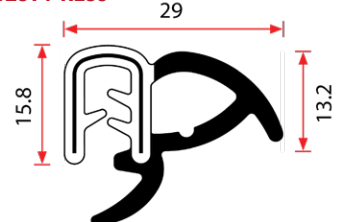

Grip Range: 1.0 - 4.0mm

090Z707-RL50

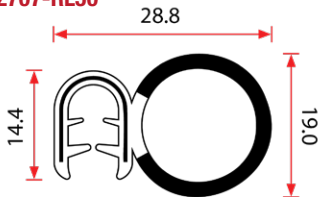

Grip Range: 1.0 - 4.0mm

NEW

12SU07-RL50

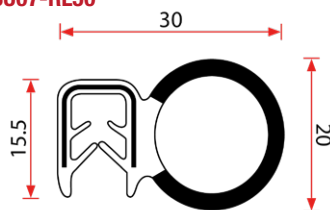

Grip Range: 0.8 - 2.5mm

090Z060-RL50

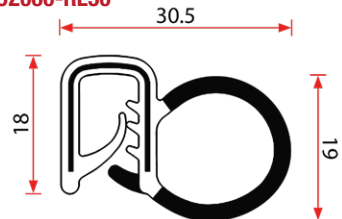

Grip Range: 2.0 - 5.0mm

Pinchweld Co Extrusions - 50m Rolls cont...

09EX10-RL50

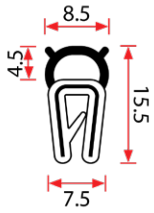

Grip Range: 0.5 - 2.0mm

090Z057-RL50

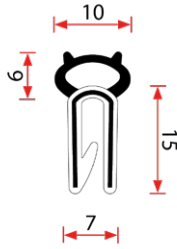

Grip Range: 1.0 - 2.0mm

090Z051-RL50

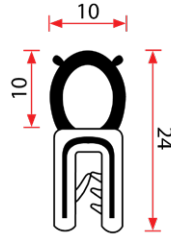

Grip Range: 0.5 - 4.0mm
Wire Cage

090Z111-RL50

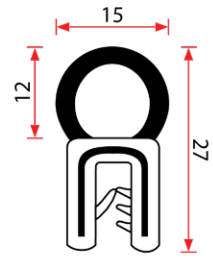

Grip Range: 1.0 - 4.5mm
Wire Cage

NEW

090Z005-RL50

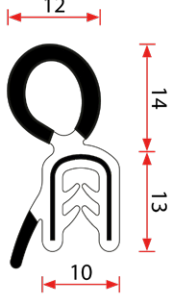

Grip Range: 1.0 - 2.5mm

090Z010-RL50

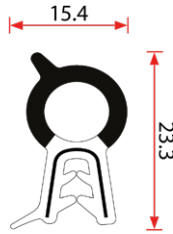

Grip Range: 1.0 - 3.0mm

NEW

090Z006-RL50

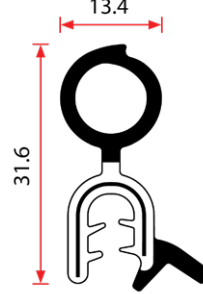

Grip Range: 1.0 - 4.0mm

NEW

090Z166-RL50

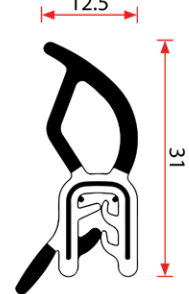

Grip Range: 0.8 - 2.0mm

090Z002-RL50



Grip Range: 0.8 - 4.0mm

090Z001-RL50

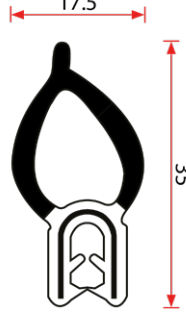

Grip Range: 1.0 - 2.5mm

090Z300-RL25

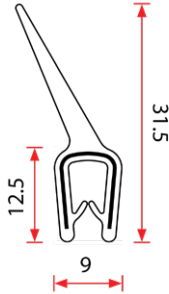

Grip Range: 0.5 - 2.0mm
25m Roll

NEW

090Z500-RL25

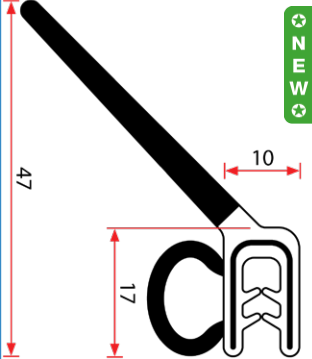

Grip Range: 1.0 - 4.0mm
Wire Cage 25m Roll

NEW

Special Order Extrusions

ALP OZ have a number of custom extrusions available on Special Order that may suit your application. We are also able to design, test and create unique products to suit your project.

ROUND NBR RUBBER SOLID CORD

CORD DIAMETER



CODE	DIAMETER	ROLL LENGTH
OZ-NC03-RL100	3mm	100m
OZ-NC04-RL100	4mm	100m
OZ-NC05-RL100	5mm	100m
OZ-NC06-RL100	6mm	100m
OZ-NC07-RL100	7mm	100m
OZ-NC08-RL100	8mm	100m
OZ-NC09-RL100	9mm	100m

CODE	DIAMETER	ROLL LENGTH
OZ-NC10-RL50	10mm	50m
OZ-NC12-RL50	12mm	50m
OZ-NC14-RL50	14mm	50m
OZ-NC16-RL25	16mm	25m
OZ-NC19-RL25	19mm	25m
OZ-NC22-RL25	22mm	25m
OZ-NC25-RL25	25mm	25m

Other sizes available on request.

ROUND EPDM RUBBER SPONGE CORD - 30m ROLLS

CORD DIAMETER



CODE	DIAMETER
OZSP219	4mm
OZSP216	5mm
OZSP489	6mm
OZSP143	7mm

CODE	DIAMETER
OZSP138	10mm
OZSP142	12.5mm
OZSP144	15mm
OZSP498	19mm



Other sizes available on request.

RECTANGULAR EPDM RUBBER SPONGE EXTRUSION - 30m ROLLS

THICKNESS

WIDTH

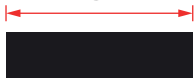

CODE	THICKNESS	WIDTH
OZSP497	3mm	32mm
OZSP495	3mm	38mm
OZSP400	6mm	6mm
OZSP401	6mm	13mm
OZSP402	6mm	19mm
OZSP403	6mm	25mm
OZSP431	6mm	32mm
OZSP404	6mm	38mm
OZSP488	6mm	50mm
OZSP405	10mm	10mm
OZSP406	10mm	13mm
OZSP501	10mm	17.5mm
OZSP8757	10mm	19mm
OZSP487	10mm	25mm
OZSP545	10mm	38mm

CODE	THICKNESS	WIDTH
OZSP408	13mm	13mm
OZSP410	13mm	19mm
OZSP411	13mm	25mm
OZSP414	13mm	50mm
OZSP423	19mm	19mm
OZSP427	19mm	25mm
OZSP424	19mm	32mm
OZSP425	19mm	38mm
OZSP428	25mm	25mm
OZSP467	25mm	32mm
OZSP429	25mm	38mm
OZSP473	25mm	50mm

Other sizes available on request.

SBR RUBBER INSERTION STRIP - 10m ROLLS



CODE	THICKNESS	WIDTH
INST1.5-050-RL10	1.5mm	50mm
INST1.5-075-RL10	1.5mm	75mm
INST1.5-100-RL10	1.5mm	100mm
INST1.5-150-RL10	1.5mm	150mm
INST1.5-200-RL10	1.5mm	200mm
INST1.5-300-RL10	1.5mm	300mm
INST3-050-RL10	3.0mm	50mm
INST3-075-RL10	3.0mm	75mm
INST3-100-RL10	3.0mm	100mm
INST3-150-RL10	3.0mm	150mm
INST3-200-RL10	3.0mm	200mm
INST3-300-RL10	3.0mm	300mm

CODE	THICKNESS	WIDTH
INST4.5-050-RL10	4.5mm	50mm
INST4.5-075-RL10	4.5mm	75mm
INST4.5-100-RL10	4.5mm	100mm
INST4.5-150-RL10	4.5mm	150mm
INST4.5-200-RL10	4.5mm	200mm
INST4.5-300-RL10	4.5mm	300mm
INST6-050-RL10	6.0mm	50mm
INST6-075-RL10	6.0mm	75mm
INST6-100-RL10	6.0mm	100mm
INST6-150-RL10	6.0mm	150mm
INST6-200-RL10	6.0mm	200mm
INST6-300-RL10	6.0mm	300mm

Other sizes available on request.

SELF-ADHESIVE EPDM FOAM TAPES

CODE	THICKNESS	WIDTH	ROLL LENGTH
OZ-8015-12-RL25	1.5mm	12mm	25m
OZ-8015-16-RL25	1.5mm	16mm	25m
OZ-8015-19-RL25	1.5mm	19mm	25m
OZ-43032-12-RL24	3.2mm	12mm	24m
OZ-43032-16-RL24	3.2mm	16mm	24m
OZ-43032-19-RL24	3.2mm	19mm	24m
OZ-43048-12-RL16	4.8mm	12mm	16m
OZ-43048-16-RL16	4.8mm	16mm	16m
OZ-43048-19-RL16	4.8mm	19mm	16m
OZ-43064-12-RL12	6.4mm	12mm	12m
OZ-43064-16-RL12	6.4mm	16mm	12m
OZ-43064-19-RL12	6.4mm	19mm	12m
OZ-43127-12-RL06	12.7mm	12mm	6m
OZ-43127-16-RL06	12.7mm	16mm	6m
OZ-43127-19-RL06	12.7mm	19mm	6m

Other sizes, materials and densities are available on request.

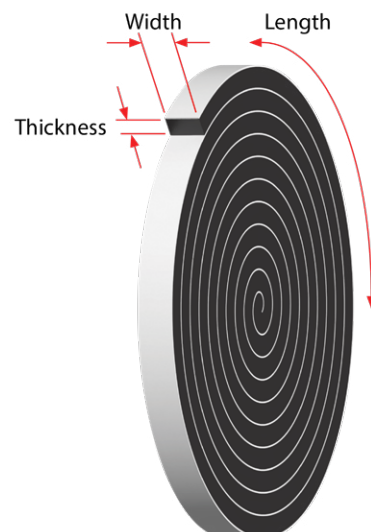

Reinforced NR/SBR Sheet Rubber - 10m Rolls



CODE	THICKNESS	WIDTH	REINFORCED
OZ1.5-120RS-RL10	1.5mm	1200mm	COTTON
OZ3-120RS-RL10	3mm	1200mm	COTTON
OZ4.5-120RS-RL10	4.5mm	1200mm	COTTON
OZ6-120RS-RL10	6mm	1200mm	COTTON
OZ9.5-120RS-RL10	9.5mm	1200mm	COTTON

Checker Plate SBR Matting - 10m Rolls

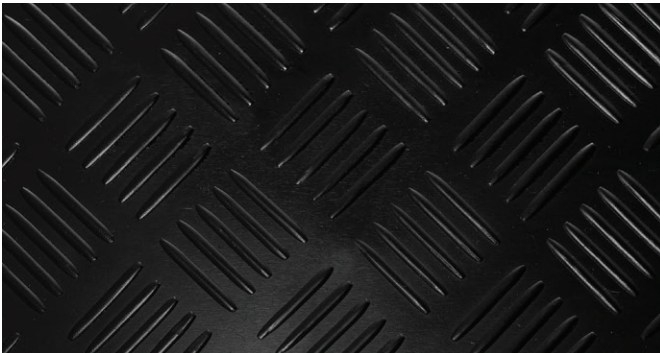

CODE	THICKNESS	WIDTH	REINFORCED
OZ3.5-120CP-RL10	3.5mm	1200mm	NO

Wide Rib SBR Sheet Matting - 10m Rolls



CODE	THICKNESS	WIDTH	REINFORCED
OZ3.5-183WR-RL10	3.5mm	1830mm	NO
OZ5-183WR-RL10	5mm	1830mm	COTTON

Horse Float Rubber / Hammer Matting - 10m Rolls

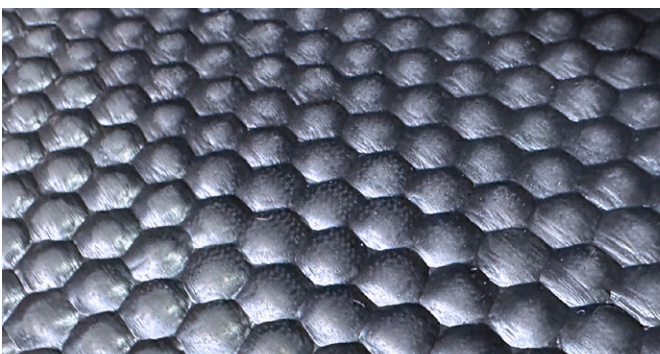

CODE	THICKNESS	WIDTH	REINFORCED
HFR08-RL10	8mm	2000mm	NYLON

Ute Matting - 10m Rolls

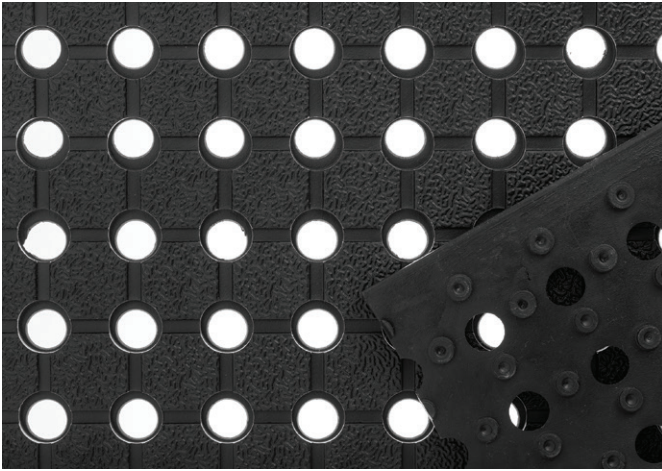

CODE	THICKNESS	WIDTH	ROLL LENGTH
OZ-183UM-RL10	10mm	1830mm	10m

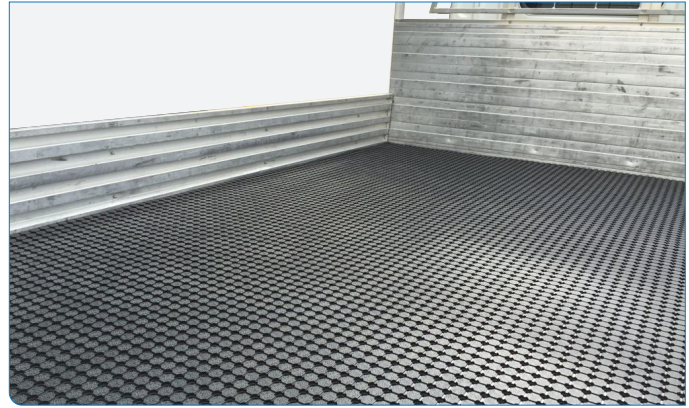

Ford Ranger Ute Mats

Custom moulded to suit tub liner.
No drilling or fastening required.

Resistant to:

- ✳ High Temperatures ✳ Most Chemicals
- ✳ Cracking ✳ Wearing ✳ Tearing ✳ UV

CODE	THICKNESS	REINFORCED	
OZ-FRM	6mm	Yes, Fibre	2012-2021 model.
OZ-FRM22	8.8 / 5.5mm	No	2022-on with Tub Liner. Excludes Raptor.

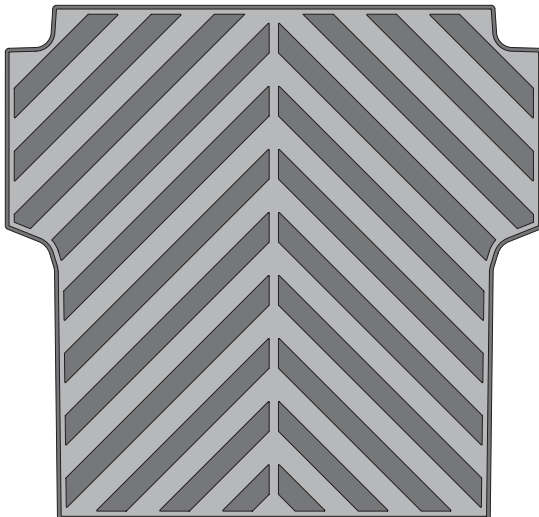

ANTI VIBRATION PAD - EPDM RUBBER

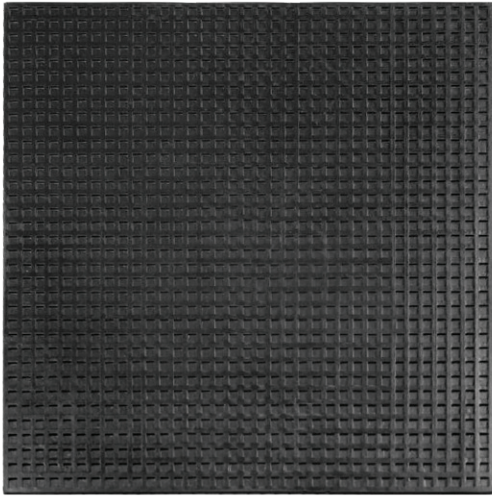

CODE	SIZE	THICKNESS
OZ-AV450	450mm*450mm	8mm

ANTI FATIGUE SLIP MAT

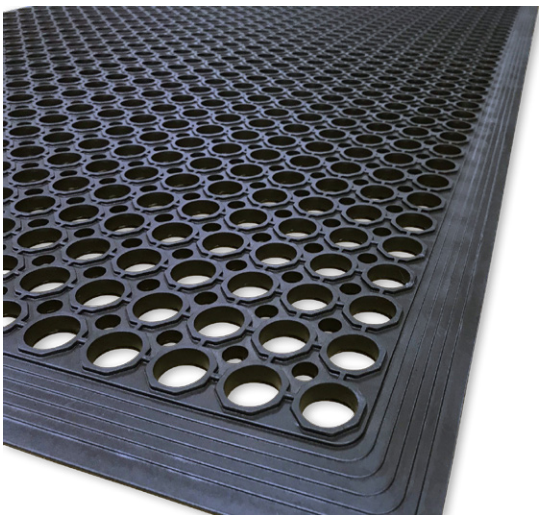

CODE	SIZE	THICKNESS
OZ-AFM12	910mm*1530mm	12mm

GYM MAT



CODE	SIZE	THICKNESS
GYMMAT	1000mm*1000mm	15mm

Wheel Arch Flares

OZ-WAF45-RL3

3m Roll

OZ-WAF45-RL6

6m Roll

OZ-WAF70-RL3

3m Roll

OZ-WAF70-RL6

6m Roll

FLOCKING - BAILEY CHANNEL - 30m ROLLS

FL017-RL30

NEW

Door Belt Extrusion Comm Outer

FL622-RL30

Suits Commodore VB-VL pillar

FL502-RL30

NEW

Suits Ford XD-XF Pillar and other



FL501-RL30

NEW

Various Falcon
Some F100 pillar

FL1150-RL30

NEW

Suits Holden HQ-WB

FL500-RL30

Suits Commodore VB-VL main bailey

FL068-RL30

Universal Suits Holden FX-HG

FL069-RL30

NEW

Jag XJ6 Nissan G60
Toyota FJ

FL026-RL30

Universal

FL426-RL30

NEW

Suits Cortina and Escort

FL628-RL30

NEW

XW-XY, XA-XB Rear, Datsun 1600

FL067-RL30

NEW

12mm x 12mm U-Section folded
Universal

FL020-RL30

NEW

Fits Coaster / Hi Ace / Troopy Bus Dual Sliding Windows

Dimensions shown above are for the size of the flocking after it has been installed.

GLAZING RUBBERS - 30m ROLLS

OZ-GL1-RL30

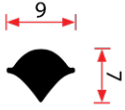

OZ-GL2-RL30

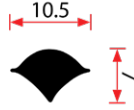

OZ-ACCOLOCK-RL30

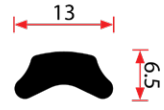

International Trucks Locking Strip

OZ-08-RL30

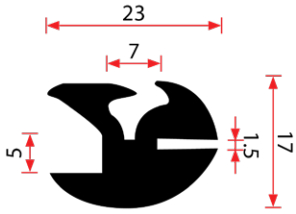

Use OZ-GL1 Locker

OZ-VAN-RL30

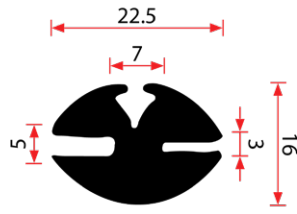

Use OZ-GL1 Locker

OZ-7782-RL30

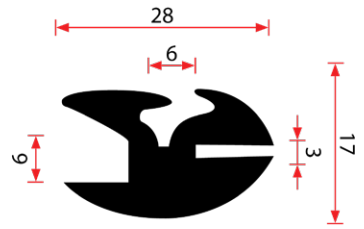

Use OZ-GL2 Locker

OZ-1059-RL30

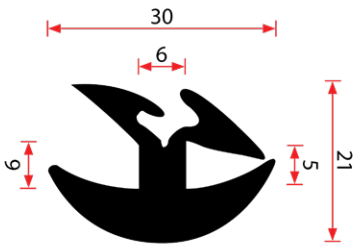

Use OZ-GL2 Locker

OZ-G5-RL30

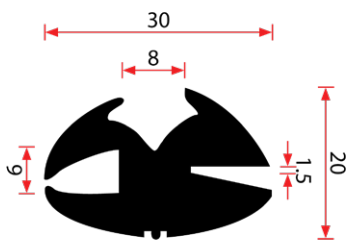

Use OZ-GL2 Locker

OZ-PBR-RL30

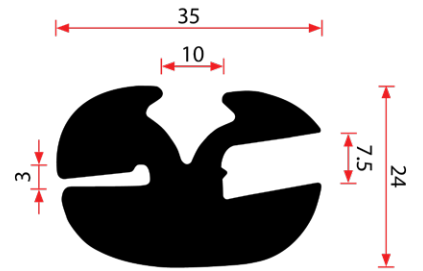

Includes locker

OZ-BUS-RUB-RL30

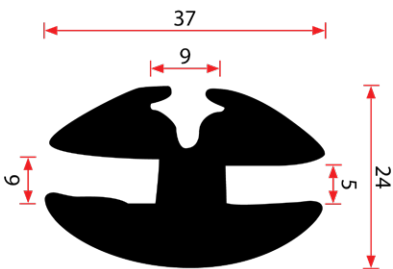

Use OZ-GL2 Locker

OZ-1317-RL30

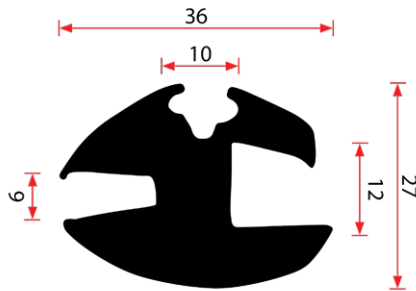

Use OZ-GL2 Locker

OZ-1318-RL30

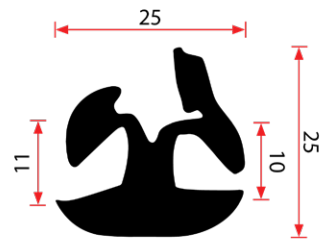

GLAZING RUBBERS - 30m ROLLS cont...

OZ-SL08-RL30

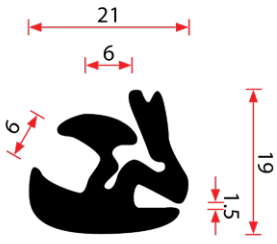

OZ-SL1059-RL30

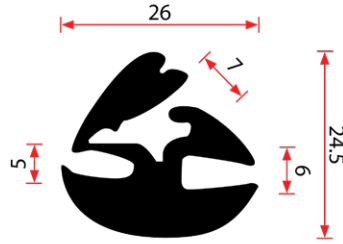

OZ-SL7782-RL30

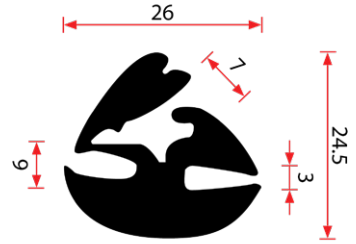

OZ-SL265-RL30

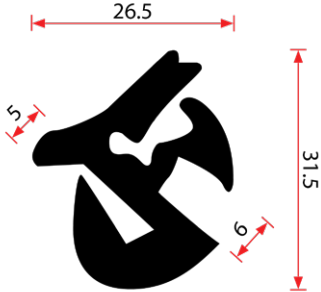

OZ-CAT10-RL30

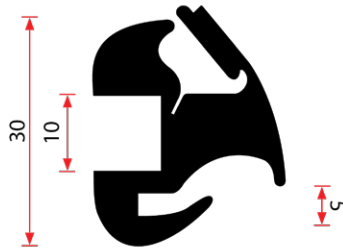

✳ Fits 10mm glass

WOB-101-RL30

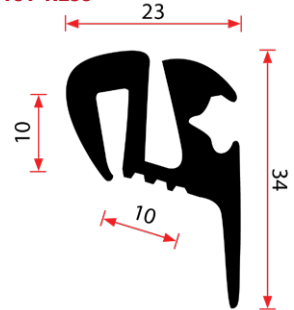

Use OZ-GL1 Locker

OZ-G209-RL30

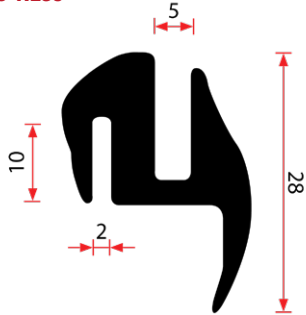

OZ-G309-RL30

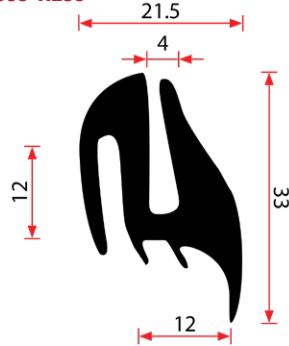

OZ-G703-RL30

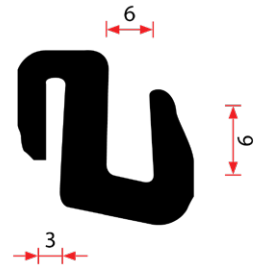

OZ-G704-RL30

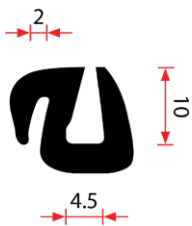

OZ-R3250-RL50

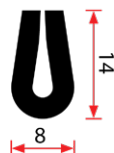

✳ 50m Roll

OZ-U723-RL50



✳ 50m Roll



WHEEL CHOCKS

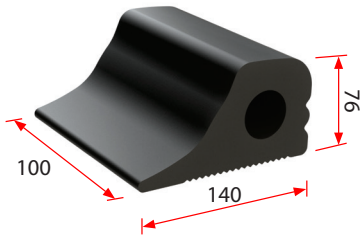

CODE	LENGTH	WIDTH	HEIGHT
WC103	140mm	100mm	76mm

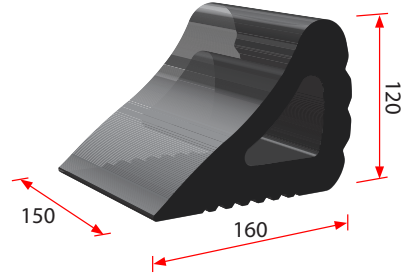

CODE	LENGTH	WIDTH	HEIGHT
WC102	160mm	150mm	120mm

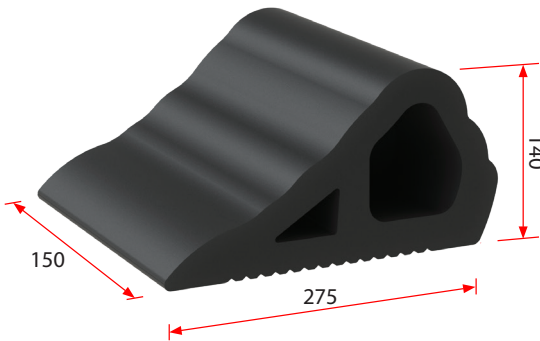

CODE	LENGTH	WIDTH	HEIGHT
WC104	275mm	150mm	140mm

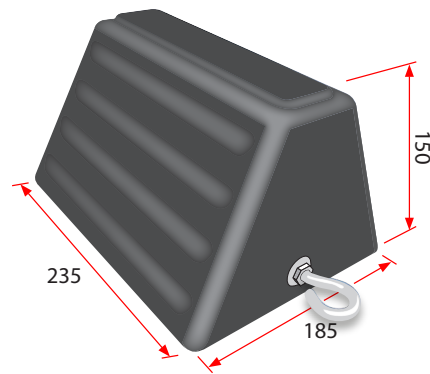

CODE	LENGTH	WIDTH	HEIGHT
WC101	185mm	235mm	150mm

TANK STRAPS

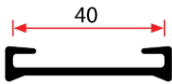

CODE	TYPE	ROLL LENGTH
TS40N-RL50	NBR	50m

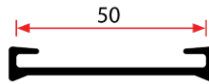

CODE	TYPE	ROLL LENGTH
TS50N-RL50	NBR	50m

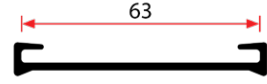

CODE	TYPE	ROLL LENGTH
TS63N-RL50	NBR	50m

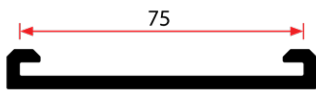

CODE	TYPE	ROLL LENGTH
TS75N-RL25	NBR	25m

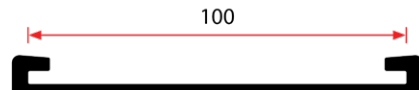

CODE	TYPE	ROLL LENGTH
TS100N-RL25	NBR	25m



DOCKING RUBBERS - 3m LENGTHS

CODE	WIDTH	HEIGHT	WALL
DR554-L3	105mm	95mm	18mm

CODE	WIDTH	HEIGHT	WALL
DR100-L3	110mm	90mm	20mm

CODE	WIDTH	HEIGHT	WALL
DR442-L3	100mm	80mm	11.5mm

CODE	WIDTH	HEIGHT	WALL
DR441-L3	75mm	65mm	10mm

CODE	WIDTH	HEIGHT	WALL
DR75-L3	75mm	65mm	15mm

CODE	WIDTH	HEIGHT	WALL
DR50-L3	50mm	40mm	8mm

CODE	WIDTH	HEIGHT	WALL
DR440-L3	50mm	40mm	8mm



All Docking Rubbers can be Cut and Drilled to customer specifications.

ADDITIONAL PRODUCTS

- ★ Bracket Straps
- ★ Self-Adhesive Taping
- ★ PVC Roller Door Seals
- ★ Thermal / Acoustic Insulation
- ★ Rubber Adhesives
- ★ Tie-Down Straps
- ★ Rubber Cutting Tools
- ★ Pelmet Extrusions
- ★ Water Jet Cut Gaskets
- ★ Custom Extrusions
- ★ Rubber Ring Seals for Pipes

ALP – Innovators in Polymer Technologies

Established in 1984, with the aim of giving its customers the best in polymer application sealing, ALP Group today is India's leading producer of automotive, industrial as well as consumer application sealing products. Spanning a diverse market comprising automotive, construction, consumer, railways, miscellaneous door and window applications and more, ALP's R&D Engineering Team develops innovative areas of sealing applications with rubber as its base product.

A pioneer in introducing EPDM weatherstrips in India, ALP has diversified into automotive applications, PVC thermoplastic and Santoprene products, insulation rubber sheets and tubs for HVAC & R applications. We offer expert and cost-effective services, right from indigenous compound formulation to production of the finished product.



THE ALP GROUP

INNOVATION

At ALP we have a culture of innovation where we encourage the free flow of ideas amongst our team of professionals. Our emphasis is on combining a scientific approach with engineering skills to create products of unmatched quality and exceptional service. Customer satisfaction being our focus and goal, we strive consistently for integration in technology.

DESIGN & DEVELOPMENT

ALP's team of 25 highly qualified and dependable engineering design personnel are one of our most valued resources, making extensive use of their product development expertise of over 15 years. Equipped with advanced design software, like CATIA V5 and AUTOCAD, our design stations and professional team are geared to developing customized products in a short lead-time.

TESTING & EVALUATION

At ALP we ensure that our products undergo rigorous testing and evaluation. Advanced state-of-the-art equipment is used to ensure maximum utility and satisfaction for the customer. Our equipment can test for properties such as water absorption, material thickness, specific gravity, cracking, hardness, wear resistance, viscosity, melting temperature, thermal insulation, molecular composition and more.

ALP – A Global Family Of Companies

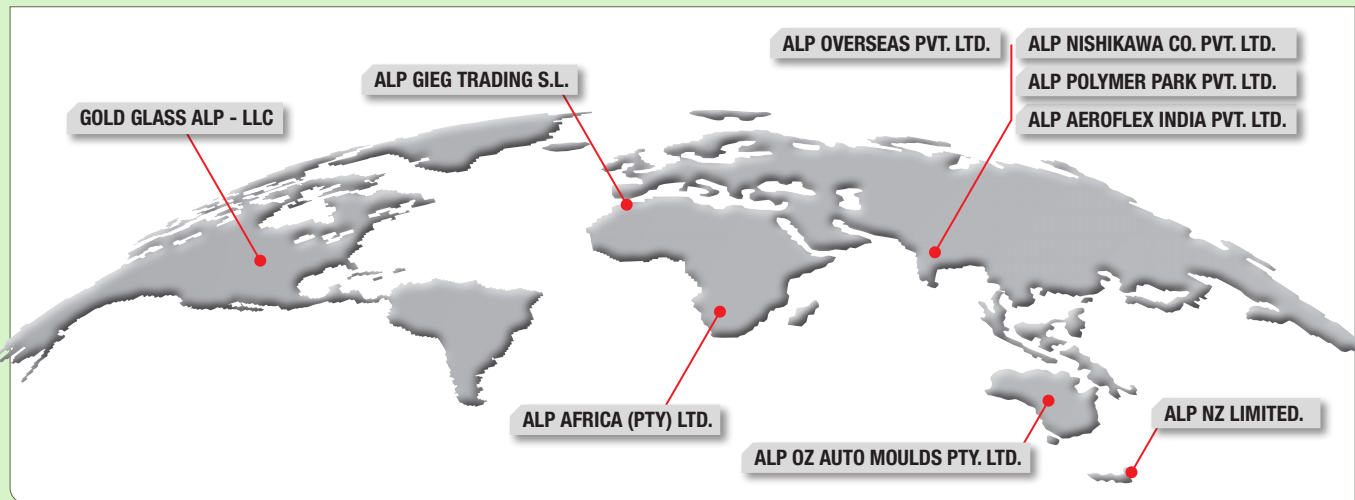

ALP – Supplying Key Industry Segments and Customer Brands

Automotive Industry

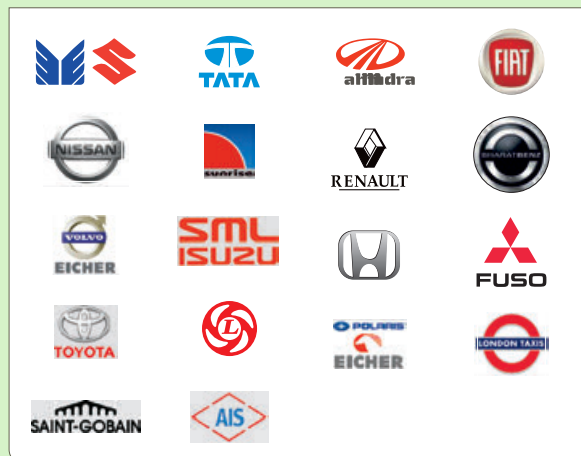

Mass Transit & Heavy Duty



Building



HVAC & R

